

ROHM Solution Simulator

2.7 V to 5.5 V Input, 2 A Single Synchronous Buck DC/DC Converter for Automotive BD9S201NUX-C / Frequency Response

This circuit simulates the frequency response of BD9S201NUX-C. You can observe the loop gain and measure phase margin. You can customize the simulation conditions by changing the parameters of components highlighted in blue.

You can simulate the circuit in the published application note: Measurement Method for Phase Margin w/ FRA. [\[JP\]](#) [\[EN\]](#) [\[CN\]](#)

General Cautions

Caution 1: The values from the simulation results are not guaranteed. Please use these results as a guide for your design.

Caution 2: These model characteristics are specifically at Ta=25°C. Thus, the simulation result with temperature variances may significantly differ from the result with the one done at actual application board (actual measurement).

Caution 3: Please refer to the datasheet for details of the technical information.

Caution 4: The characteristics may change depending on the actual board design and ROHM strongly recommend to double check those characteristics with actual board where the chips will be mounted on.

1 Simulation Schematic

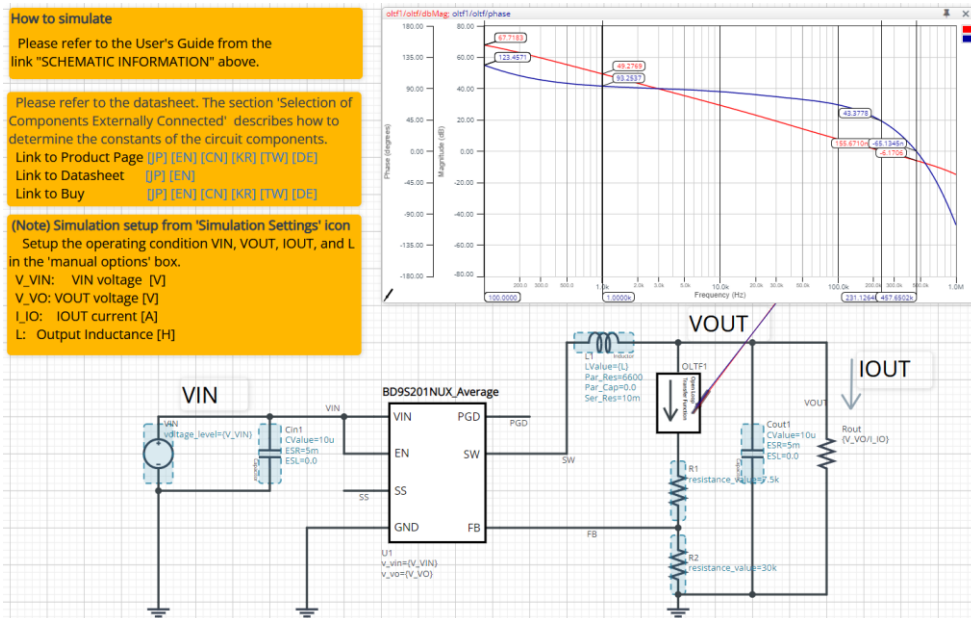

Figure 1. Simulation Circuit

2 How to simulate

The simulation settings, such as frequency range or convergence options, are configurable from the 'Simulation Settings' shown in Figure 2, and Table 1 shows the default setup of the simulation.

In case of simulation convergence issue, you can change advanced options to solve.

The parameters V_VIN, V_VO, I_IO, and L are defined in the 'Manual Options'.

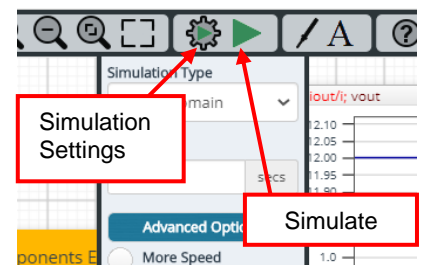

Figure 2. Simulation Settings and execution

Table 1. Simulation settings default setup

Parameters	Default	Note
Simulation Type	Frequency-Domain	(Do not change Simulation Type)
Start Frequency	100 Hz	Simulate the frequency response for the frequency range from 100Hz to 1MHz.
End Frequency	1Meg Hz	
Advanced options	Balanced Convergence Assist	
Manual Options	“.param V_VIN=5 V_VO=1.0 I_IO=2 L=1.0u”	See “Simulation Condition” for details

3 Simulation Conditions

3.1 How to define V_{IN} , V_{OUT} , I_{OUT} , and L

These parameters are used to setup the simulation conditions and BD9S201NUX_Average model parameters, therefore these are defined in the Manual Options as the common variables.

Table 2 shows the default value of V_{IN} , V_{OUT} , I_{OUT} , and L. Those values are defined and can be set in the 'Manual Options' text box from Simulation Settings as shown in Figure 3.

The output voltage of V_{IN} and the load resistance R_L are automatically set according to those parameters.

Table 2. Simulation Conditions

Parameters	Variable Name	Default Value	Units	Descriptions
V_{IN}	V_VIN	5	V	Input Voltage
V_{OUT}	V_VO	1.0	V	Output Voltage
I_{OUT}	I_IO	2	A	Output Current
L	L	1.0u	H	Output Inductor

(Note 1) Set it to the guaranteed operating range of the DC/DC Converter.

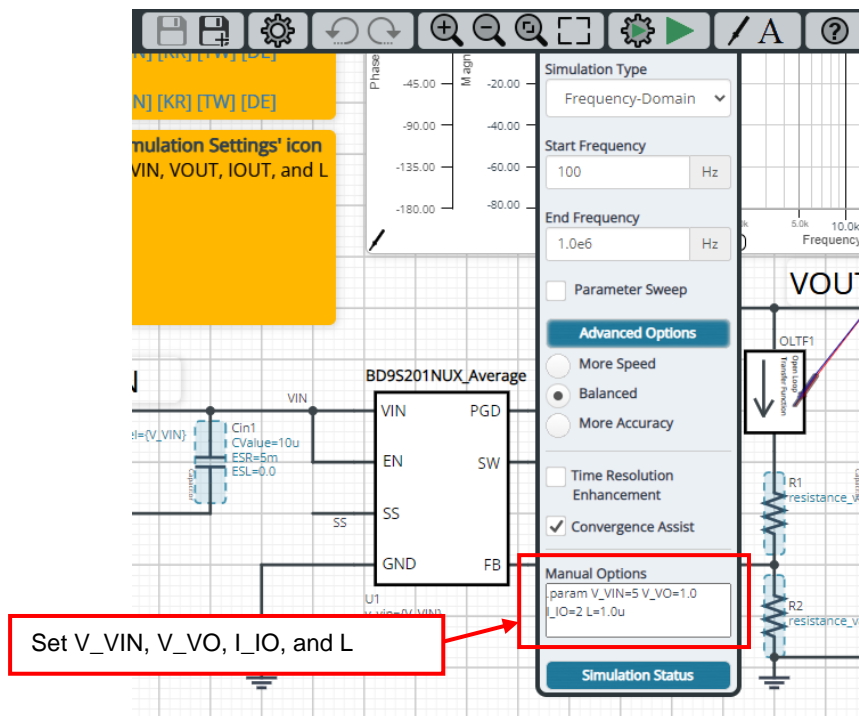

Figure 3. Definition of V_{IN} , V_{OUT} , I_{OUT} , and L

3.2 Resistive Load R_L

R_L is the resistive load and its resistance is determined from V_{OUT} and I_{OUT} . The resistance value is defined as the equation below.

Table 3. Resistive load

Instance Name	Default Value	Unit
RL	{V_VO/I_IO}	Ω

4 BD9S201NUX_Average model

The simulation model in this circuit is designed for frequency response, and the functions not related to frequency response are not implemented.

Table 4. BD9S201NUX_Average model pins used for frequency response

Pin Name	Description
VIN	Power supply input
EN	Enable input
FB	Output voltage feedback pin. Inverting input node of the error amplifier.
SW	Switching node
GND	Ground

Table 5. BD9S201NUX_Average model pins NOT used for frequency response

Pin Name	Description
SS	Input is ignored (no switching operation in this model)
PGD	Output is ignored (no power good in this model)

4.1 BD9S201NUX_Average Model Parameters

BD9S201NUX_Average model has its parameters shown in Table 6. All the parameters are pre-defined and fixed in the simulation. V_VIN is substituted to V_VIN as shown in Table 6.

Table 6. Parameter List

Parameters	Values	Description
V_VIN	V_VIN	VIN voltage
V_VO	V_VO	VOOUT voltage

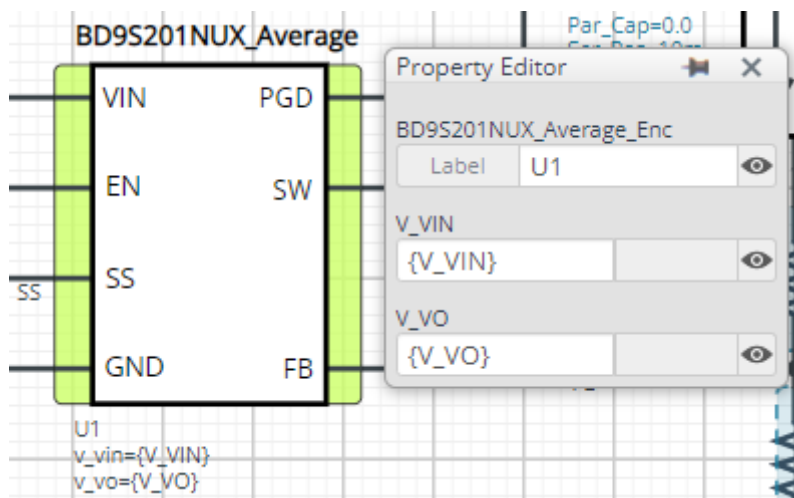

Figure 4. Property Editor of BD9S201NUX_Average model

5 Peripheral Components

To set parameters of components, open 'property' by double click or right click on a component. You can input a value to a property text box if available. Please refer to the hands-on manual for more details.

5.1 Bill of Material

Table 7 shows the list of components used in the simulation schematic. Each of the capacitor and inductor has the parameters of equivalent circuit shown below. The default value of equivalent components are set to zero except for the parallel resistance of L and series resistance of capacitors. You can modify the values of each component.

Table 7. List of components used in the simulation circuit

Type	Instance Name	Default Value	Units
Capacitor	Cin1	10	μF
	Cout1	10	μF
Inductor	L1	1.0	μH
Resistor	R1	7.5	$\text{k}\Omega$
	R2	30	$\text{k}\Omega$

5.2 Capacitor Equivalent Circuits

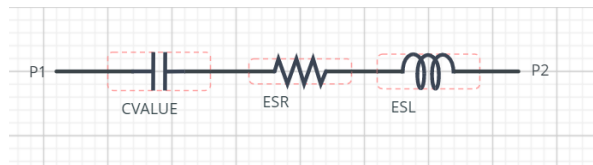
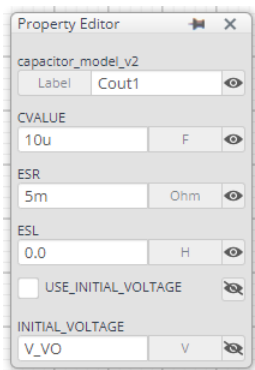

(a) Property editor

(b) Equivalent circuit

Figure 5. Capacitor property editor and equivalent circuit

The default value of ESR is 5 m Ω .

5.3 Inductor Equivalent Circuits

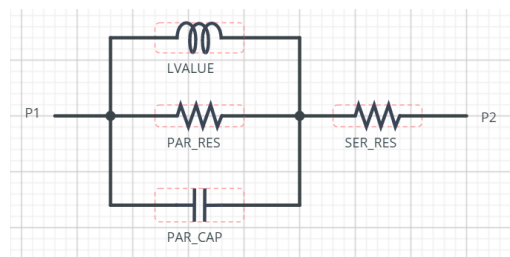
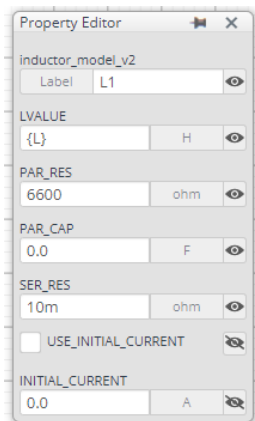

(a) Property editor

(b) Equivalent circuit

Figure 6. Inductor property editor and equivalent circuit

The default value of PAR_RES is 6.6 k Ω .

(Note 2) These parameters can take any positive value or zero in simulation but it does not guarantee the operation of the IC in any condition. Refer to the datasheet to determine adequate value of parameters.

6 Open Loop Transfer Function (OLTF) Monitor

OLTF1 is the insert model to measure AC open loop transfer function and is inserted to acquire the gain and phase output. To monitor the gain and phase from OLTF1, select probe items 'dbMag' for gain and 'phase' for phase plot, respectively from 'property' of OLTF1.

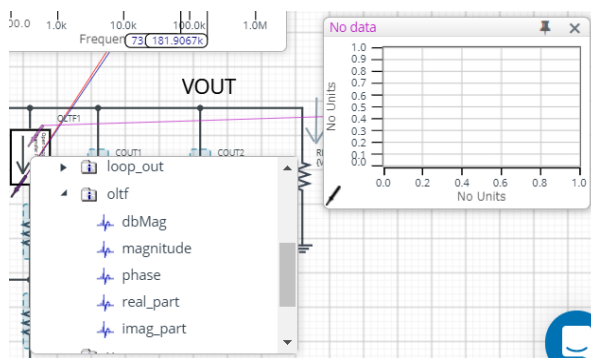

Figure 7. Probe Items of OLTF1

7 Link to the product information and tools

7.1 DC/DC Converter

BD9S201NUX-C : Single Synchronous Buck DC/DC Converter for Automotive. [\[JP\]](#) [\[EN\]](#) [\[CN\]](#) [\[KR\]](#) [\[TW\]](#) [\[DE\]](#)

7.2 General Purpose Chip Resistors

MCR01MZPF : Thick Film Chip Resistors. [\[JP\]](#) [\[EN\]](#) [\[CN\]](#) [\[KR\]](#) [\[TW\]](#) [\[DE\]](#)

Technical Articles and Tools can be found in the Design Resources on the product web page.

Notes

- 1) The information contained herein is subject to change without notice.
- 2) Before you use our Products, please contact our sales representative and verify the latest specifications :
- 3) Although ROHM is continuously working to improve product reliability and quality, semiconductors can break down and malfunction due to various factors.
Therefore, in order to prevent personal injury or fire arising from failure, please take safety measures such as complying with the derating characteristics, implementing redundant and fire prevention designs, and utilizing backups and fail-safe procedures. ROHM shall have no responsibility for any damages arising out of the use of our Products beyond the rating specified by ROHM.
- 4) Examples of application circuits, circuit constants and any other information contained herein are provided only to illustrate the standard usage and operations of the Products. The peripheral conditions must be taken into account when designing circuits for mass production.
- 5) The technical information specified herein is intended only to show the typical functions of and examples of application circuits for the Products. ROHM does not grant you, explicitly or implicitly, any license to use or exercise intellectual property or other rights held by ROHM or any other parties. ROHM shall have no responsibility whatsoever for any dispute arising out of the use of such technical information.
- 6) The Products specified in this document are not designed to be radiation tolerant.
- 7) For use of our Products in applications requiring a high degree of reliability (as exemplified below), please contact and consult with a ROHM representative : transportation equipment (i.e. cars, ships, trains), primary communication equipment, traffic lights, fire/crime prevention, safety equipment, medical systems, servers, solar cells, and power transmission systems.
- 8) Do not use our Products in applications requiring extremely high reliability, such as aerospace equipment, nuclear power control systems, and submarine repeaters.
- 9) ROHM shall have no responsibility for any damages or injury arising from non-compliance with the recommended usage conditions and specifications contained herein.
- 10) ROHM has used reasonable care to ensure the accuracy of the information contained in this document. However, ROHM does not warrants that such information is error-free, and ROHM shall have no responsibility for any damages arising from any inaccuracy or misprint of such information.
- 11) Please use the Products in accordance with any applicable environmental laws and regulations, such as the RoHS Directive. For more details, including RoHS compatibility, please contact a ROHM sales office. ROHM shall have no responsibility for any damages or losses resulting non-compliance with any applicable laws or regulations.
- 12) When providing our Products and technologies contained in this document to other countries, you must abide by the procedures and provisions stipulated in all applicable export laws and regulations, including without limitation the US Export Administration Regulations and the Foreign Exchange and Foreign Trade Act.
- 13) This document, in part or in whole, may not be reprinted or reproduced without prior consent of ROHM.



Thank you for your accessing to ROHM product informations.
More detail product informations and catalogs are available, please contact us.

ROHM Customer Support System

<http://www.rohm.com/contact/>