

# B-004. 1-Phase 2-level Full Bridge Inverter $P_{OUT}=20kW$

ROHM Solution Simulator Schematic Information



2023. Feb  
64UG100E Rev.005

## Simulation Parameters

Component name	Component	Default	Simulation Setting Range
Vin	Input voltage	500Vdc	
Vo	Output voltage	200Vac	
Io	Output current	100Aac	
fsw	Switching frequency	20kHz	10k – 300kHz
Tj	Temperature	100°C	
Vd1-4+	Gate Drive voltage H	18V	10 – 20V
Vd1-4-	Gate Drive voltage L	-4V	-4 – 0V
Vdin	Signal voltage level	5V	

## Devices

Component Name	Component	Default	Simulation Setting Range
Q1, Q2	MOSSBDx2	Selectable	
GD-IC1-4	Gate Driver	BM61S41RFV-C	
R sink1-4	Resistor for sink	ESR18 1Ω	0.1 -
R source1-4	Resistor for source	ESR18 2Ω	0.1 -
L1	Inductor	500μH	10μH - 2mH
Ro	Output Resistor	{Vo/Io}	

## Simulation Circuit

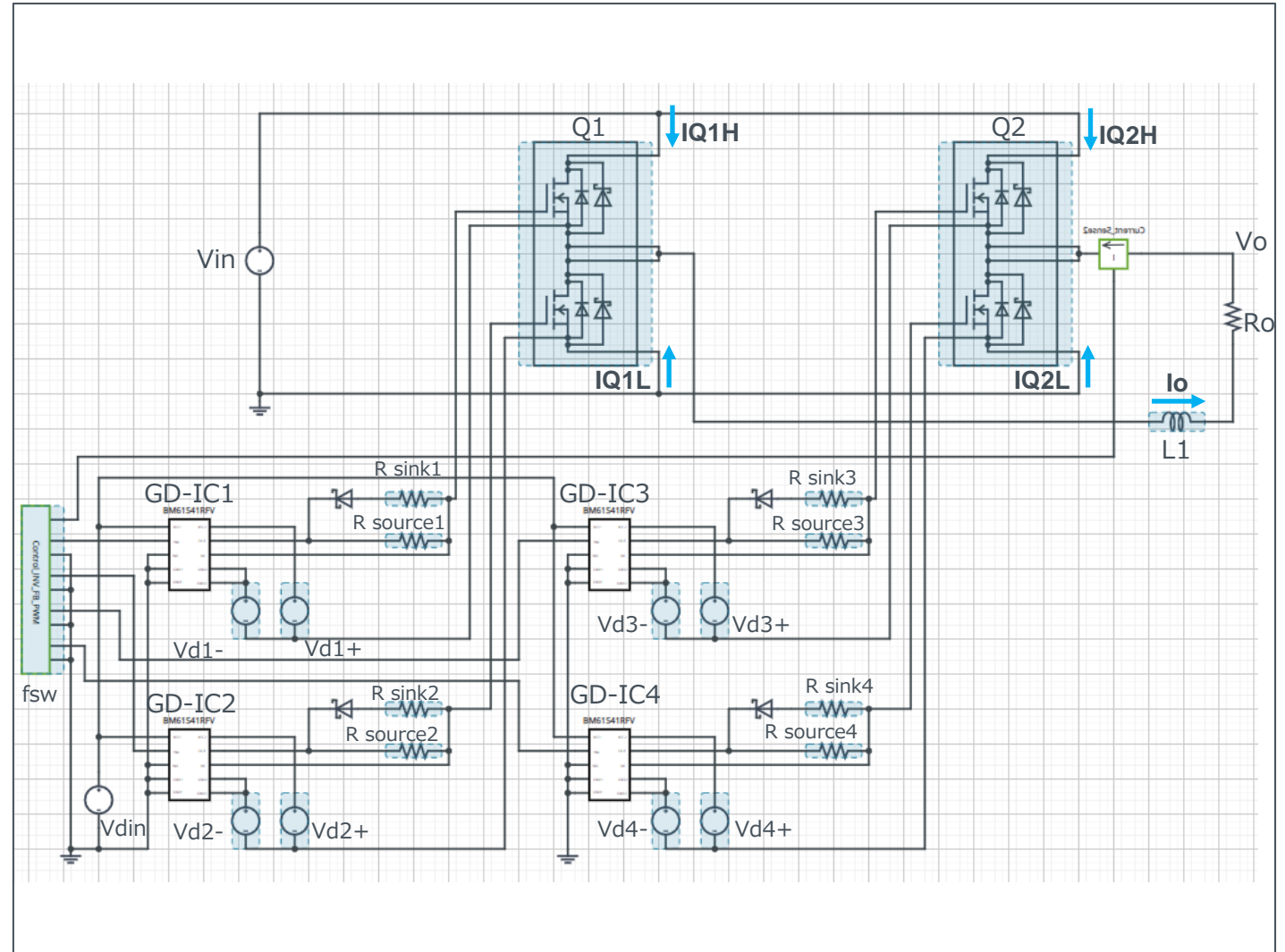

Note: The Loss\_calc component is a utility module to support power loss calculation and does not affect the simulation results of circuit operation or performance.

# B-004. 1-Phase 2-level Full Bridge Inverter $P_{OUT}=20kW$

ROHM Solution Simulator Schematic Information



2023. Feb  
64UG100E Rev.005

## Selectable Devices

Component name	Component	Product No.	feature
Q1, Q2	MOSSBDx2	BSM080D12P2C008	800V, 120A
		BSM120D12P2C005 (*)	1200V, 120A

\* Default device

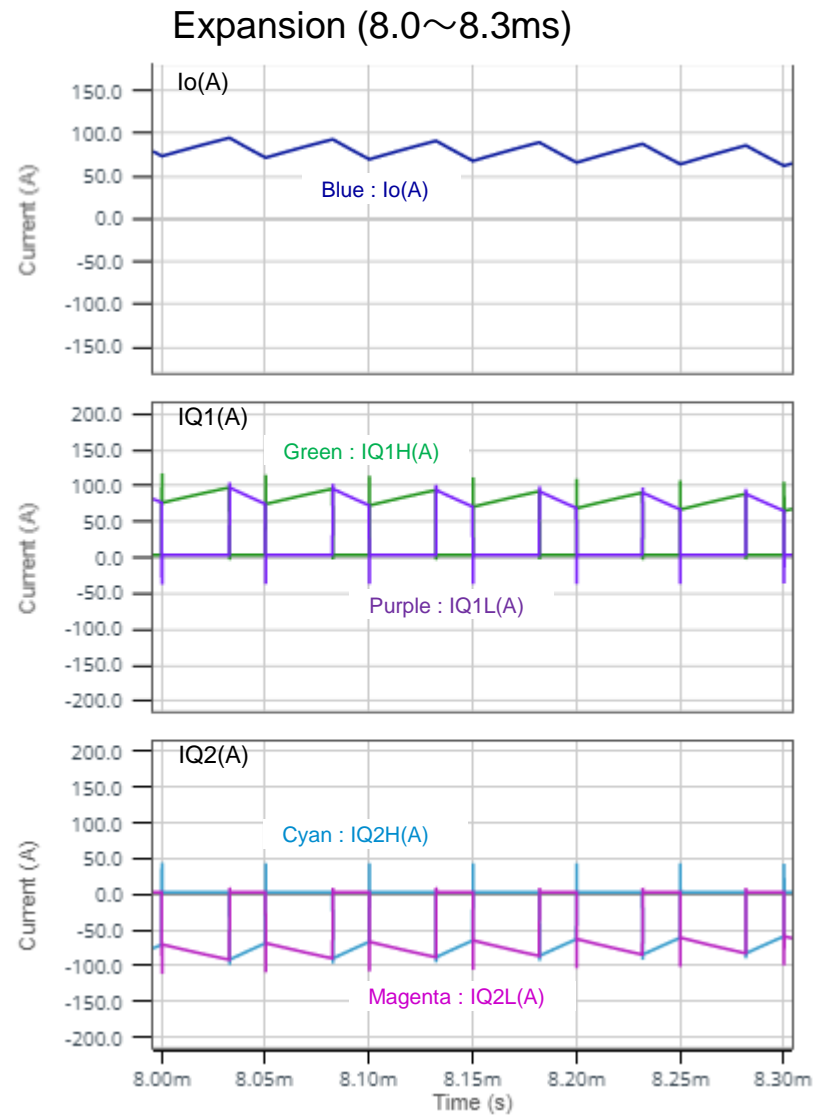
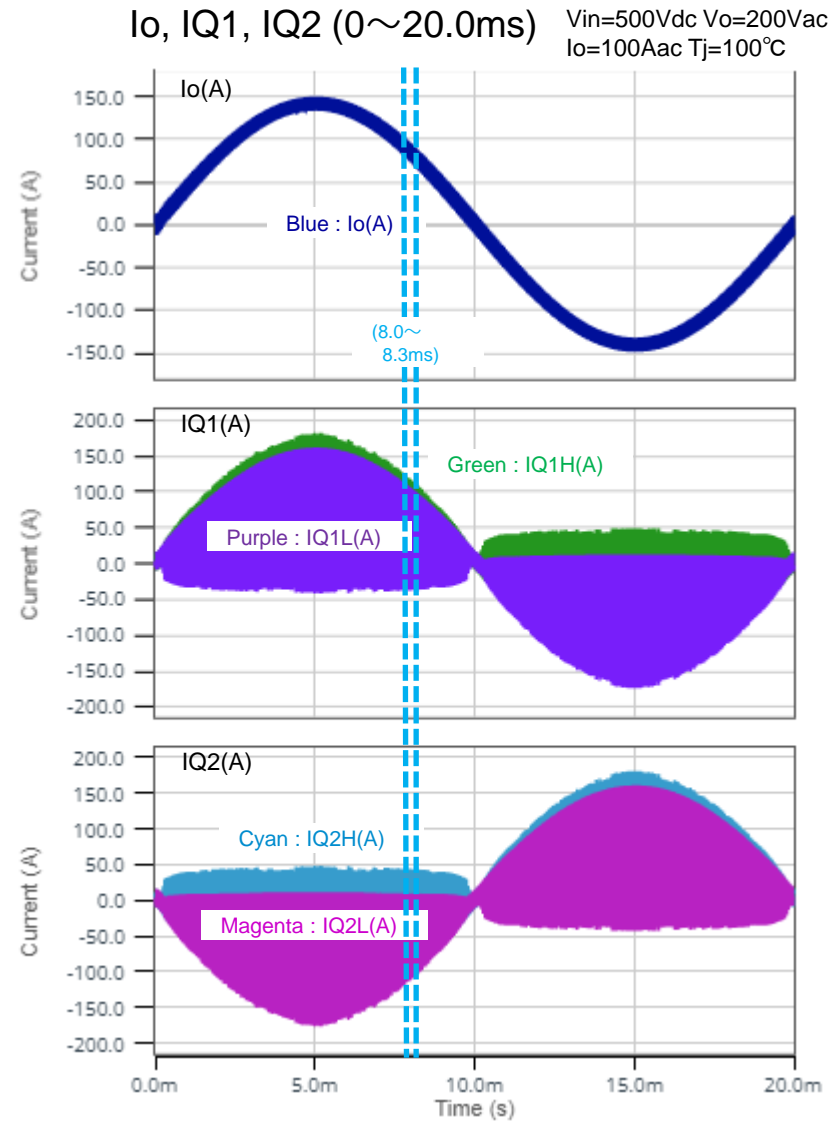

# Efficiency, Power Dissipation



ROHM Solution Simulator Schematic Information

2023. Feb  
64UG100E Rev.005

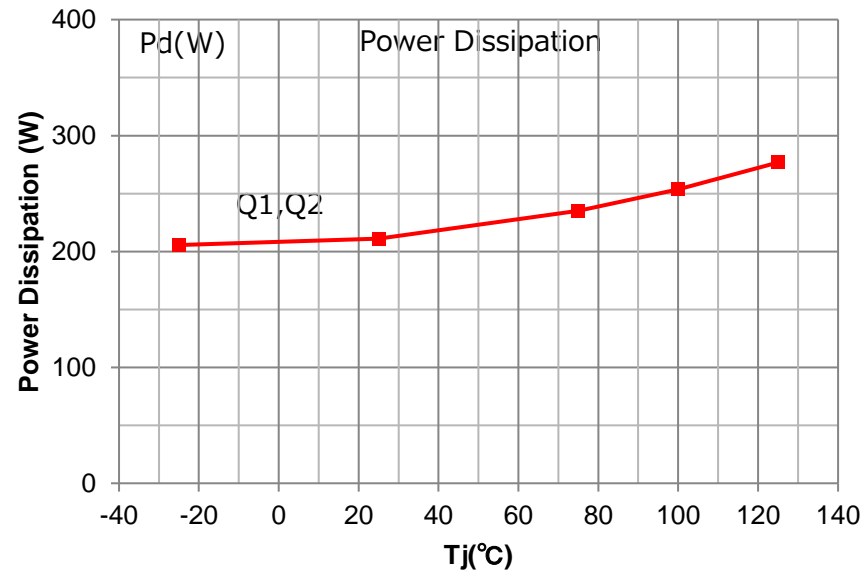
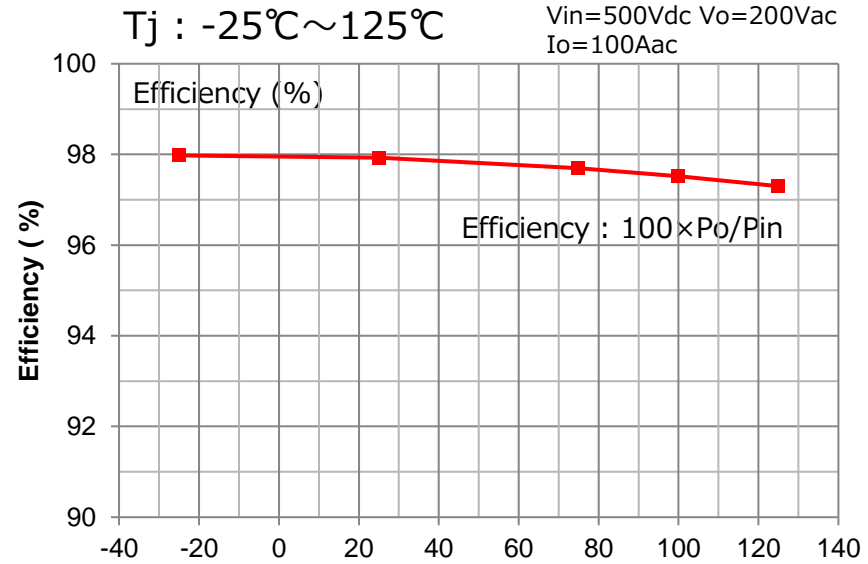
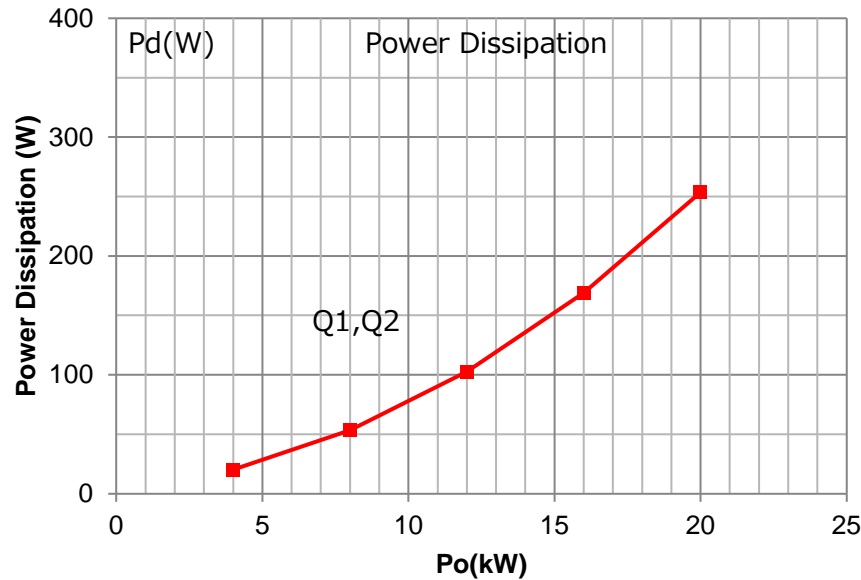
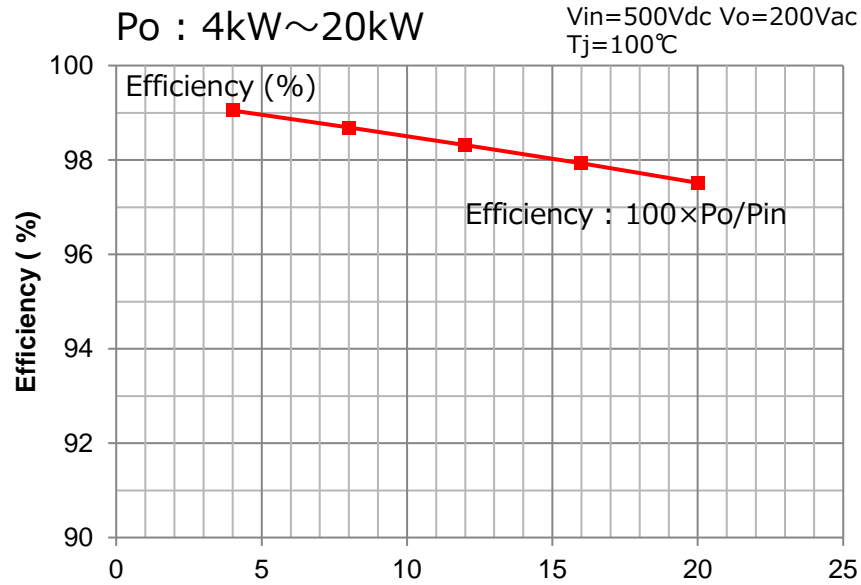

# How to change the devices

Right-click on the device → Select Properties → Pull down “SpiceLib Part” → Select the product

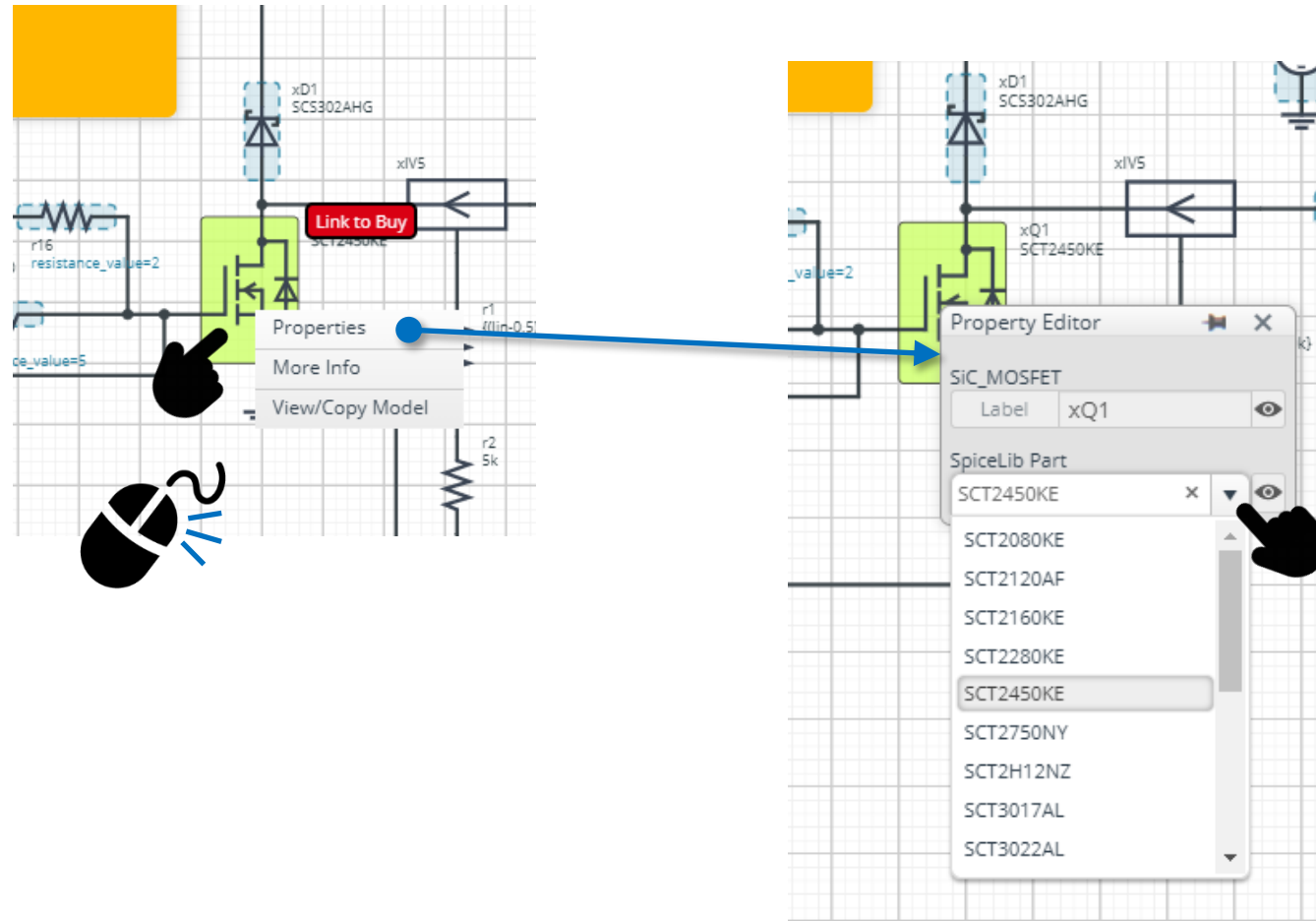

Loss Calculation Model outputs the instantaneous value of power loss and its integration.

2023. Feb  
64UG100E Rev.005

## Loss calculation model 'Loss\_calc'

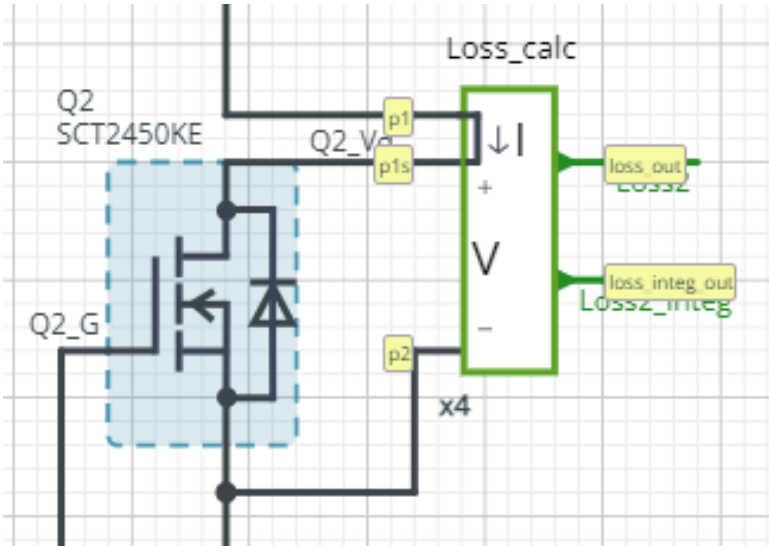

$$loss\_out(t) = I(t) \times V(t)$$

$$loss\_integ\_out = \int_0^t loss\_out(t) dt$$

I : Current through p1 to p1s

V : Voltage between p1s and p2

## Waveform example

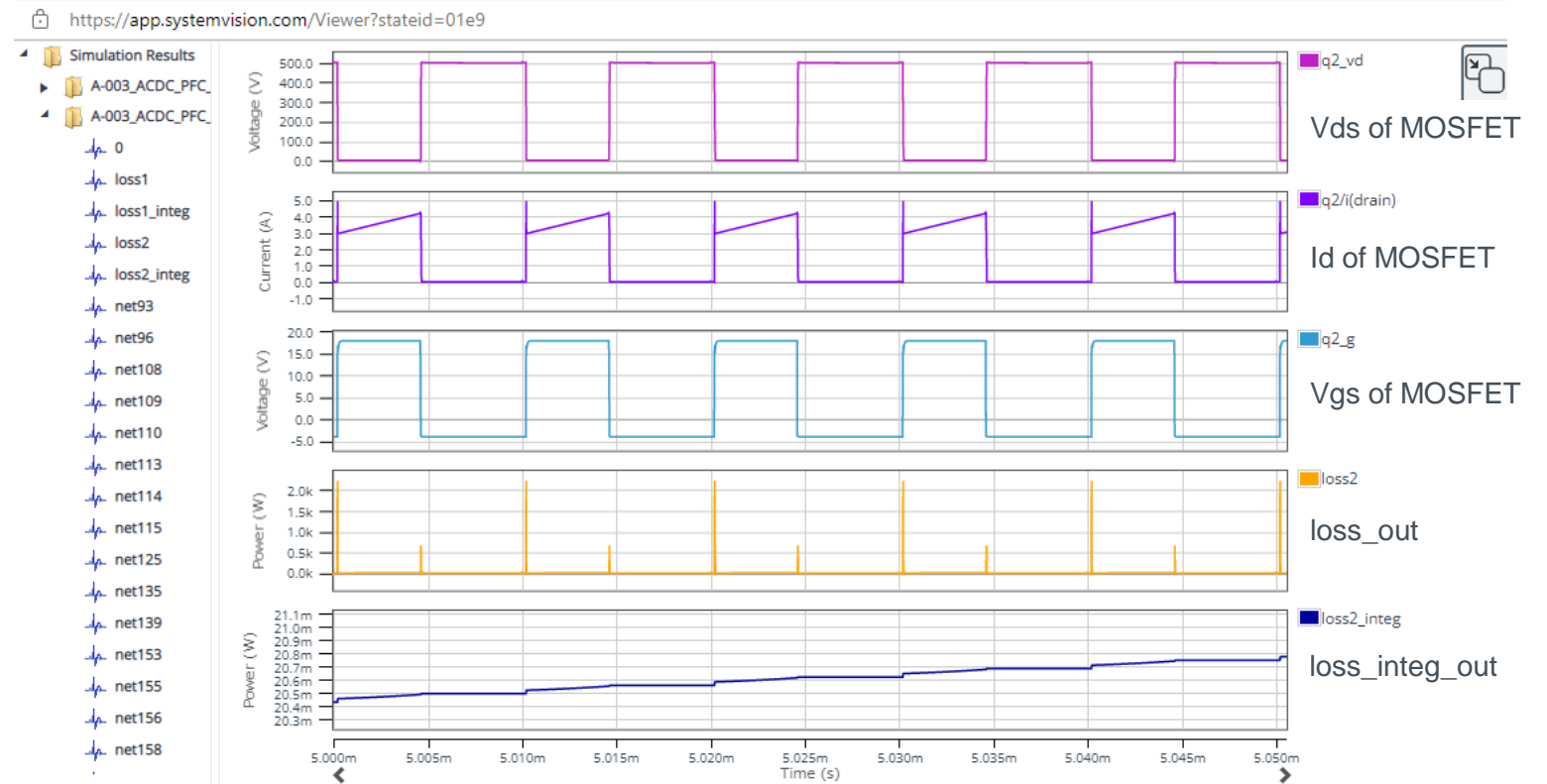

## Notes

- 1) The information contained herein is subject to change without notice.
- 2) Before you use our Products, please contact our sales representative and verify the latest specifications :
- 3) Although ROHM is continuously working to improve product reliability and quality, semiconductors can break down and malfunction due to various factors.  
Therefore, in order to prevent personal injury or fire arising from failure, please take safety measures such as complying with the derating characteristics, implementing redundant and fire prevention designs, and utilizing backups and fail-safe procedures. ROHM shall have no responsibility for any damages arising out of the use of our Products beyond the rating specified by ROHM.
- 4) Examples of application circuits, circuit constants and any other information contained herein are provided only to illustrate the standard usage and operations of the Products. The peripheral conditions must be taken into account when designing circuits for mass production.
- 5) The technical information specified herein is intended only to show the typical functions of and examples of application circuits for the Products. ROHM does not grant you, explicitly or implicitly, any license to use or exercise intellectual property or other rights held by ROHM or any other parties. ROHM shall have no responsibility whatsoever for any dispute arising out of the use of such technical information.
- 6) The Products specified in this document are not designed to be radiation tolerant.
- 7) For use of our Products in applications requiring a high degree of reliability (as exemplified below), please contact and consult with a ROHM representative : transportation equipment (i.e. cars, ships, trains), primary communication equipment, traffic lights, fire/crime prevention, safety equipment, medical systems, servers, solar cells, and power transmission systems.
- 8) Do not use our Products in applications requiring extremely high reliability, such as aerospace equipment, nuclear power control systems, and submarine repeaters.
- 9) ROHM shall have no responsibility for any damages or injury arising from non-compliance with the recommended usage conditions and specifications contained herein.
- 10) ROHM has used reasonable care to ensure the accuracy of the information contained in this document. However, ROHM does not warrants that such information is error-free, and ROHM shall have no responsibility for any damages arising from any inaccuracy or misprint of such information.
- 11) Please use the Products in accordance with any applicable environmental laws and regulations, such as the RoHS Directive. For more details, including RoHS compatibility, please contact a ROHM sales office. ROHM shall have no responsibility for any damages or losses resulting non-compliance with any applicable laws or regulations.
- 12) When providing our Products and technologies contained in this document to other countries, you must abide by the procedures and provisions stipulated in all applicable export laws and regulations, including without limitation the US Export Administration Regulations and the Foreign Exchange and Foreign Trade Act.
- 13) This document, in part or in whole, may not be reprinted or reproduced without prior consent of ROHM.



Thank you for your accessing to ROHM product informations.  
More detail product informations and catalogs are available, please contact us.

## ROHM Customer Support System

<http://www.rohm.com/contact/>