

A-018. 3-Phase Interleaved PFC $V_{in}=200V$, $I_{in}=7.5A$, DCM (Synchronous FETs)

Simulation Parameters

Parameters	Descriptions	Default	Simulation Setting Range
V_{in}	Input voltage	200Vac 50Hz	
I_{in}	Input current	7.5Aac	
V_o	Output voltage	500Vdc	300 – 500Vdc
fsw1,2,3	Switching frequency	50kHz	10k – 300k
T_j	Temperature	100°C	
Vd1-6+	Gate Drive voltage H	15V	10 – 20V
Vd1-6-	Gate Drive voltage L	-4V	-4 – 0V
Vdin	Signal voltage level	5V	

Devices

Component Name	Component	Default	Simulation Setting Range
Q1 – Q6	SJ-MOSFET	Selectable	
GD-IC1-6	Gate Driver	BM61M41RFV-C	
R sink1-6	Resistor for sink	ESR18 2Ω	0.1 -
R source1-6	Resistor for source	ESR18 5Ω	0.1 -
L1, L2, L3	Inductor	300μH	10μH - 2mH
C1	Capacitor	50nF	
BR	Bridge Diode	600V 10A ideal diode	

Simulation Circuit

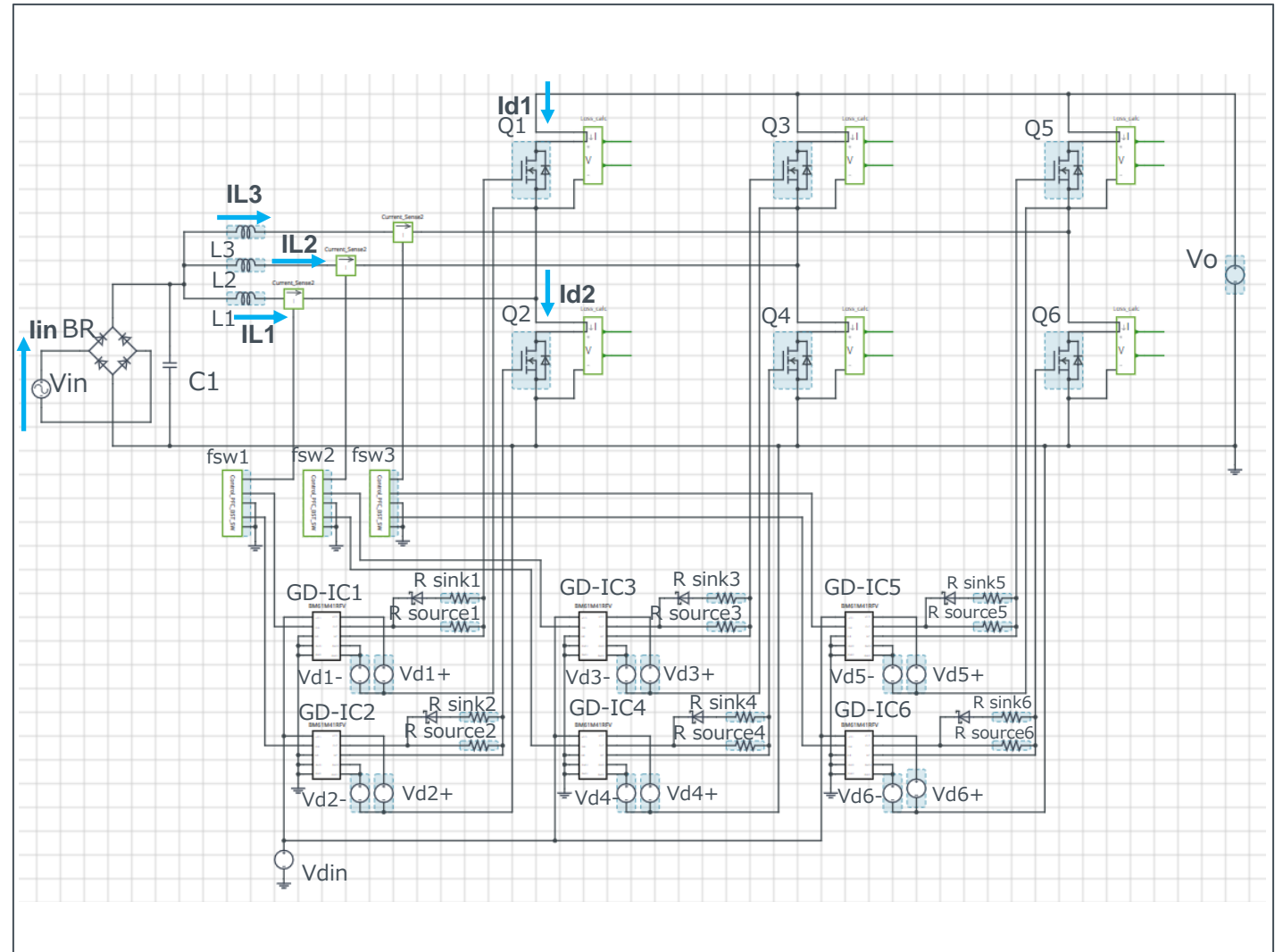

Note: The Loss_calc component is a utility module to support power loss calculation and does not affect the simulation results of circuit operation or performance.

A-018. 3-Phase Interleaved PFC $V_{in}=200V$, $I_{in}=7.5A$, DCM (Synchronous FETs)



ROHM Solution Simulator Schematic Information

2023. Feb
64UG112E Rev.004

Selectable Devices

Component name	Component	Product No.	feature
Q1 – Q4	SJ-MOSFET	R6004JNX	600V, 4A
		R6006JNX	600V, 6A
		R6009JNX	600V, 9A
		R6018JNX	600V, 18A
		R6020JNX	600V, 20A
		R6025JNX	600V, 25A
		R6030JNZ4 (*)	600V, 30A
		R6050JNZ4	600V, 50A

* Default device

Selectable Devices

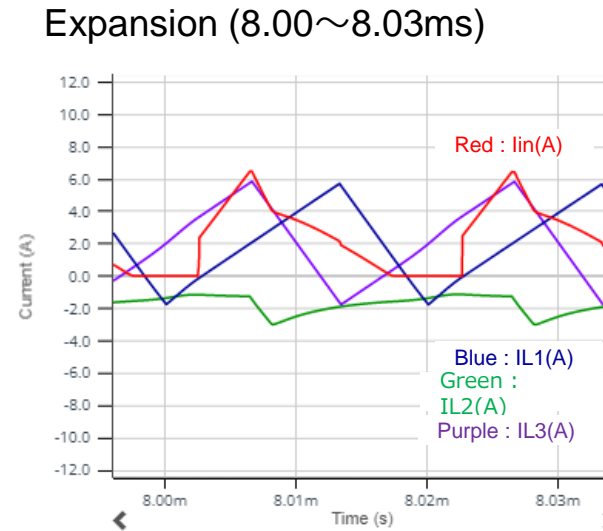
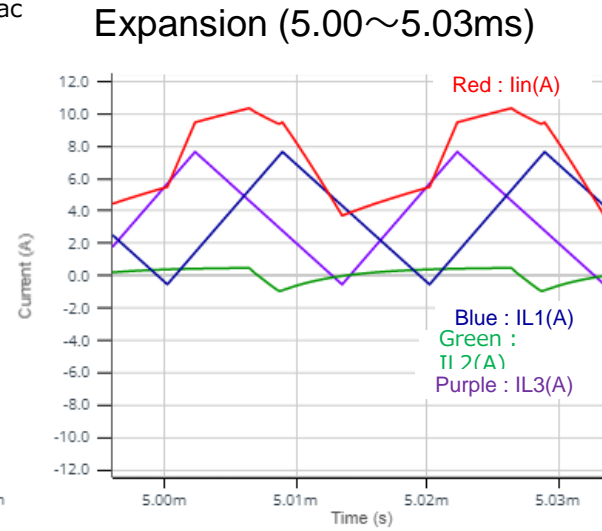
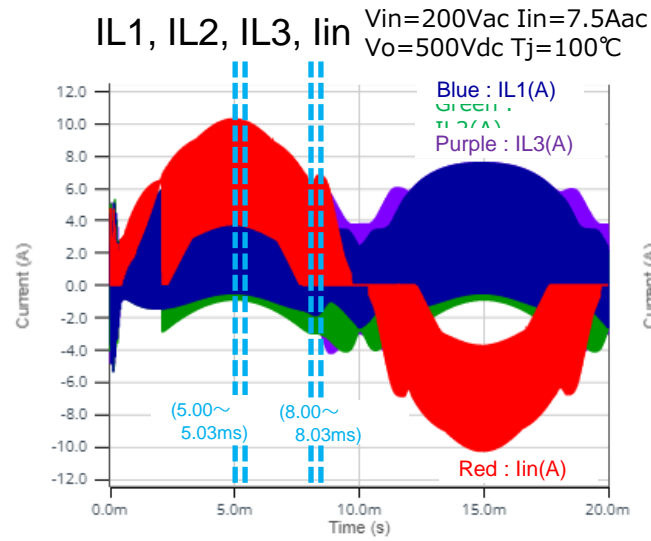

Simulation Waveform2

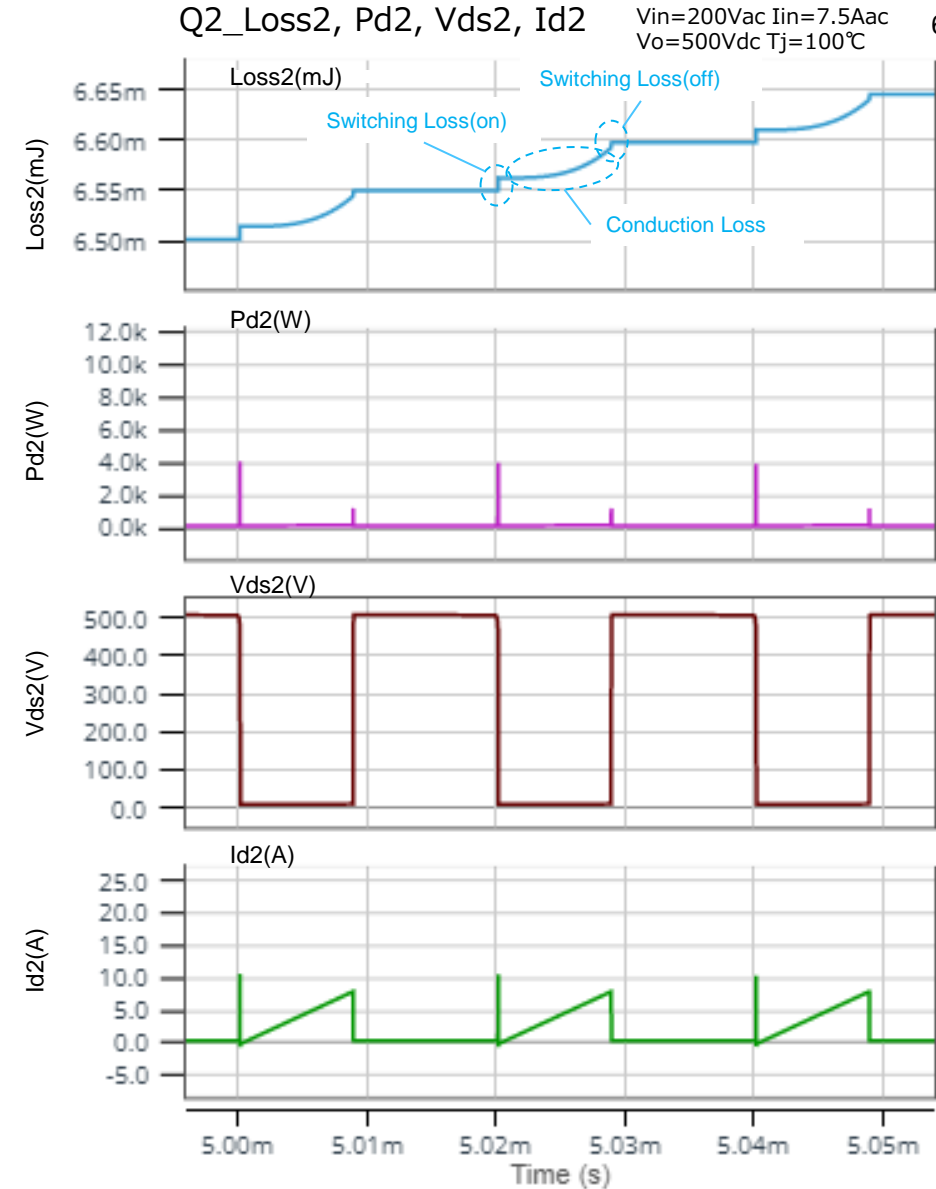
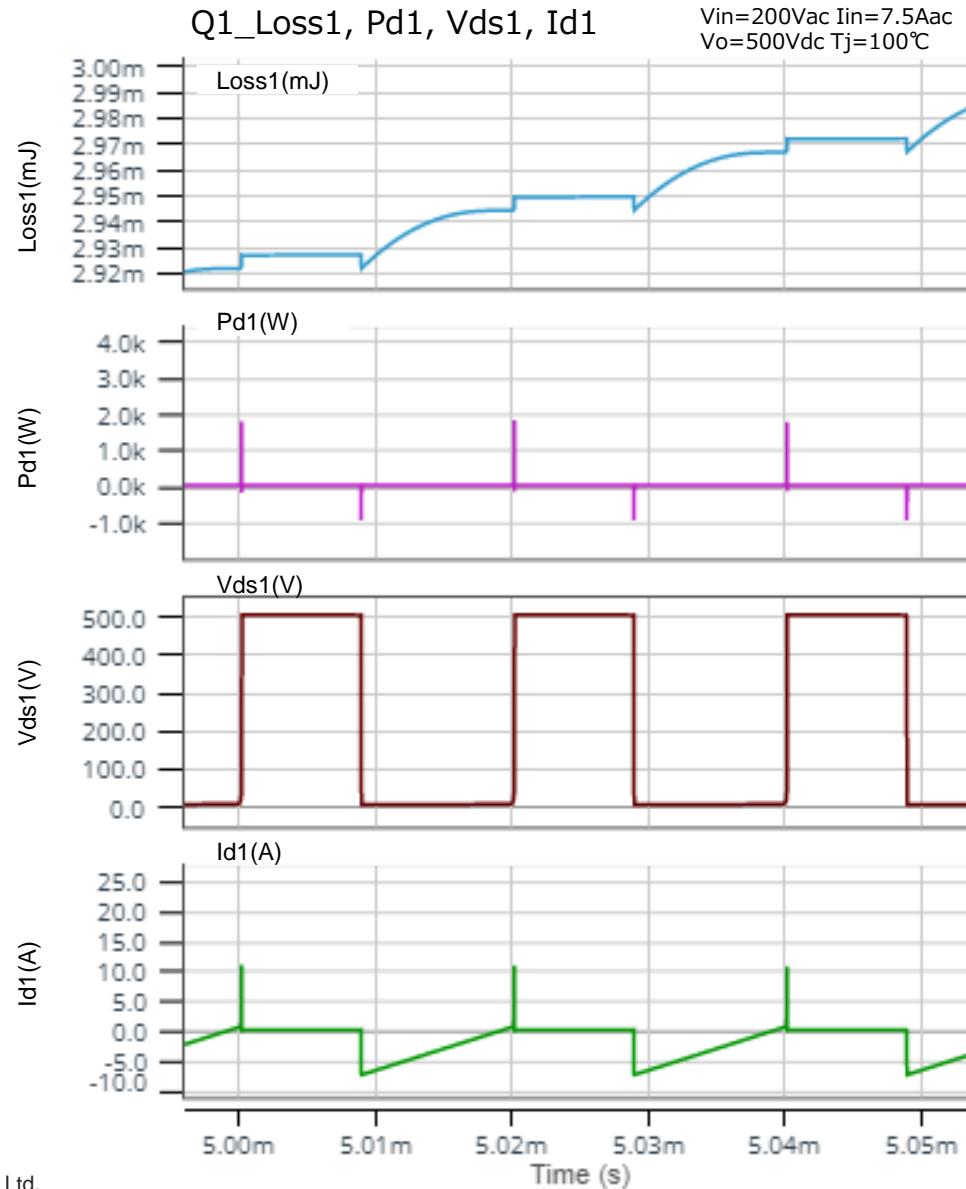

Efficiency, Power Dissipation

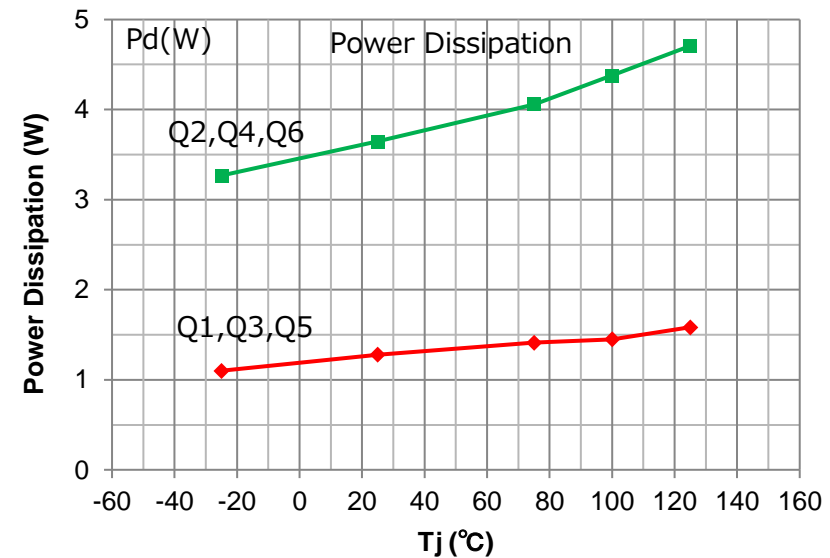
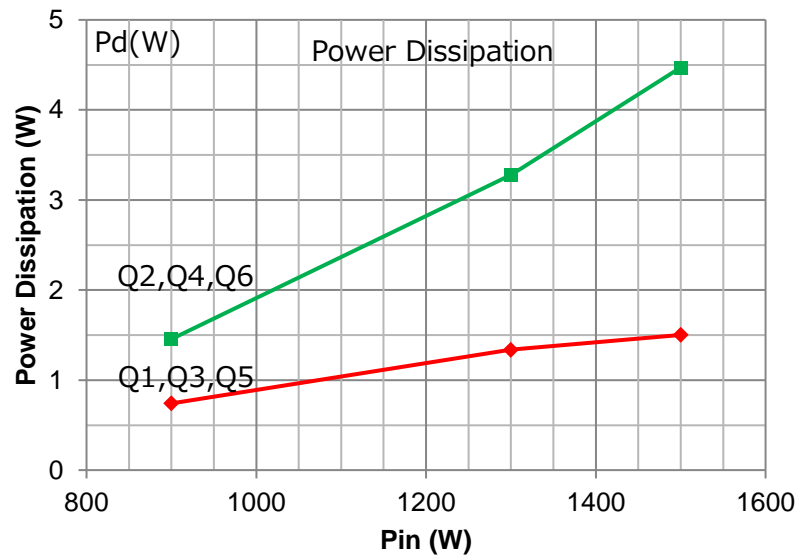
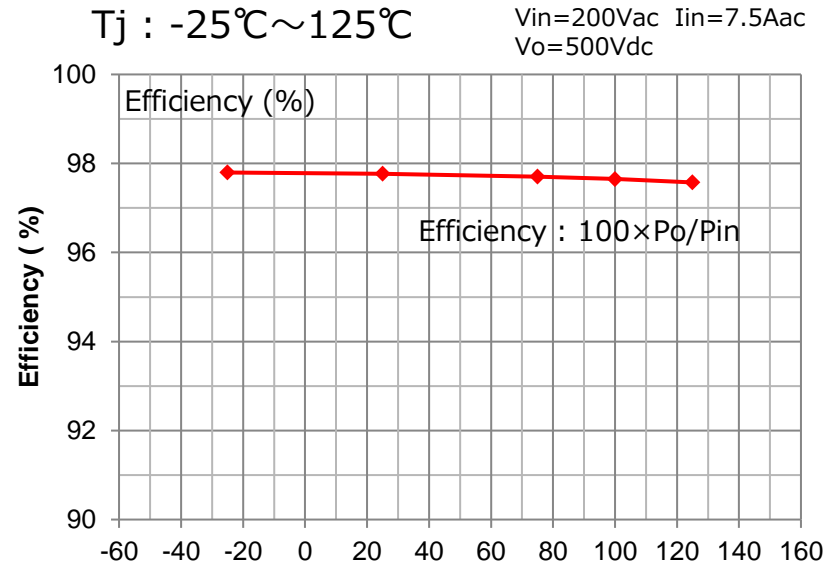
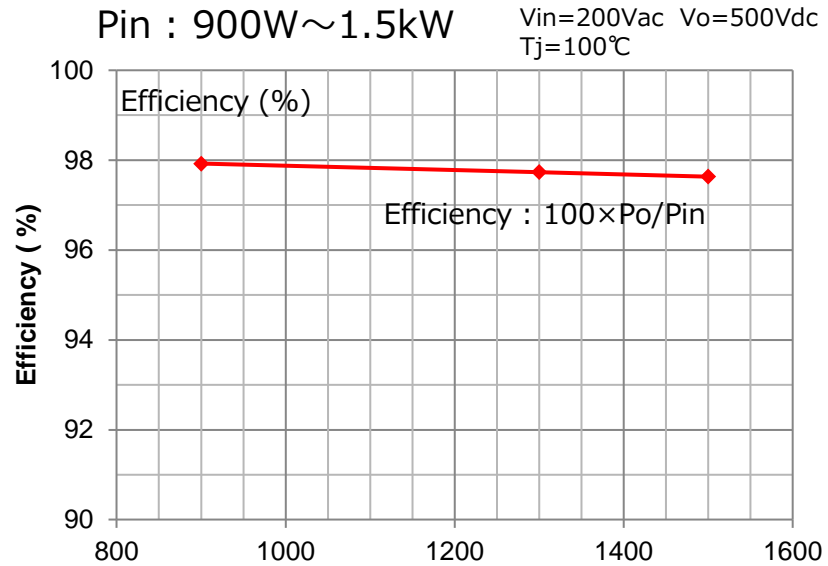

How to change the devices

Right-click on the device → Select Properties → Pull down “SpiceLib Part” → Select the product

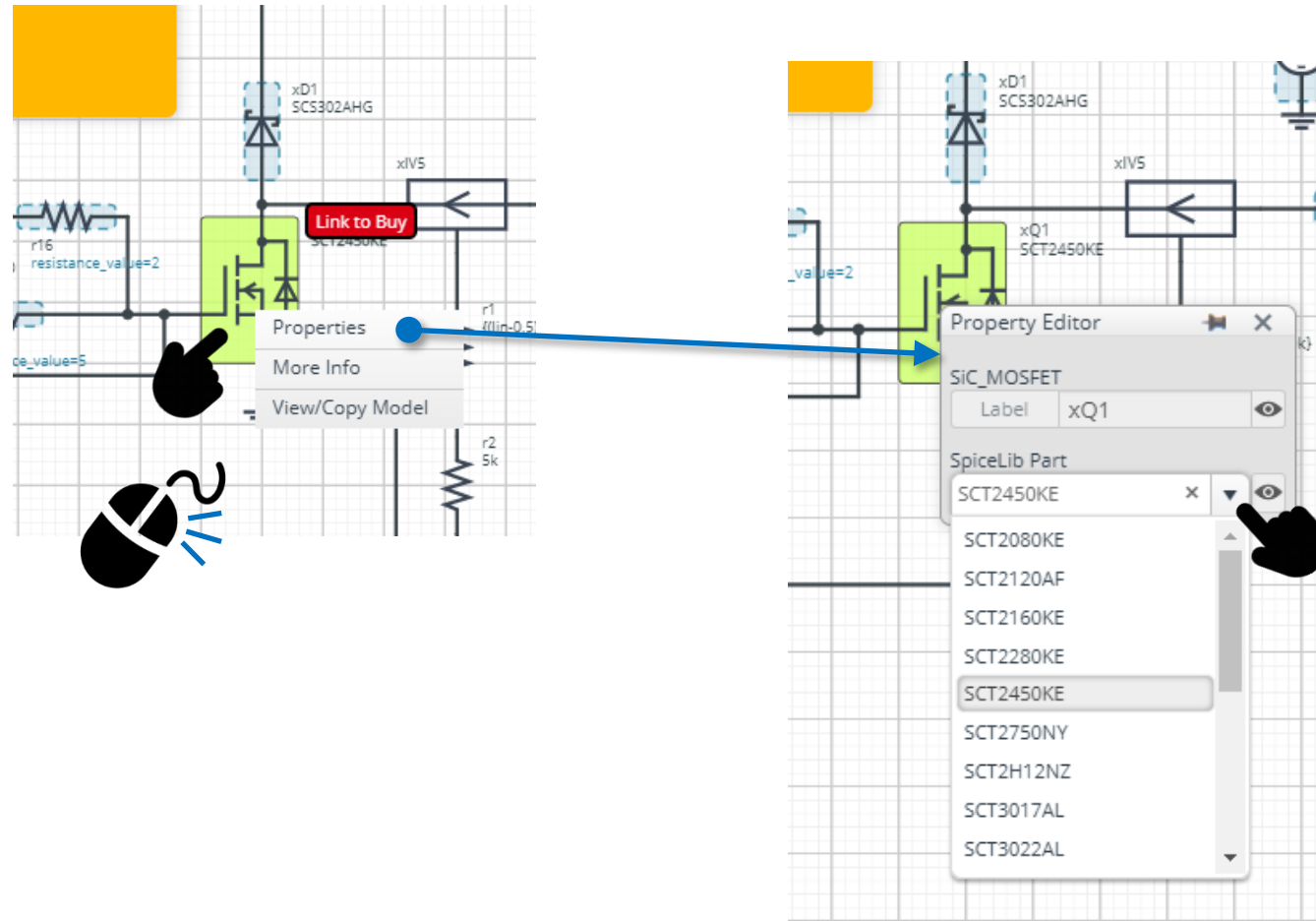

Loss Calculation Model outputs the instantaneous value of power loss and its integration.

2023. Feb
64UG112E Rev.004

Loss calculation model 'Loss_calc'

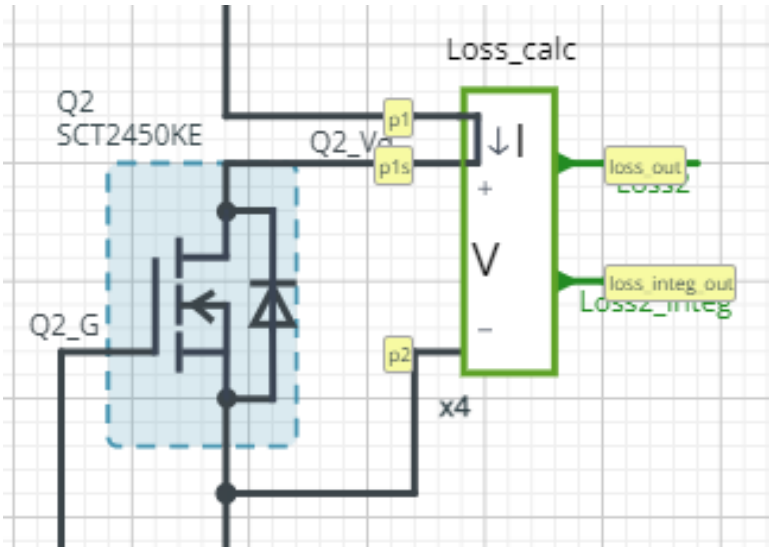

$$loss_out(t) = I(t) \times V(t)$$

$$loss_integ_out = \int_0^t loss_out(t) dt$$

I : Current through p1 to p1s

V : Voltage between p1s and p2

Waveform example

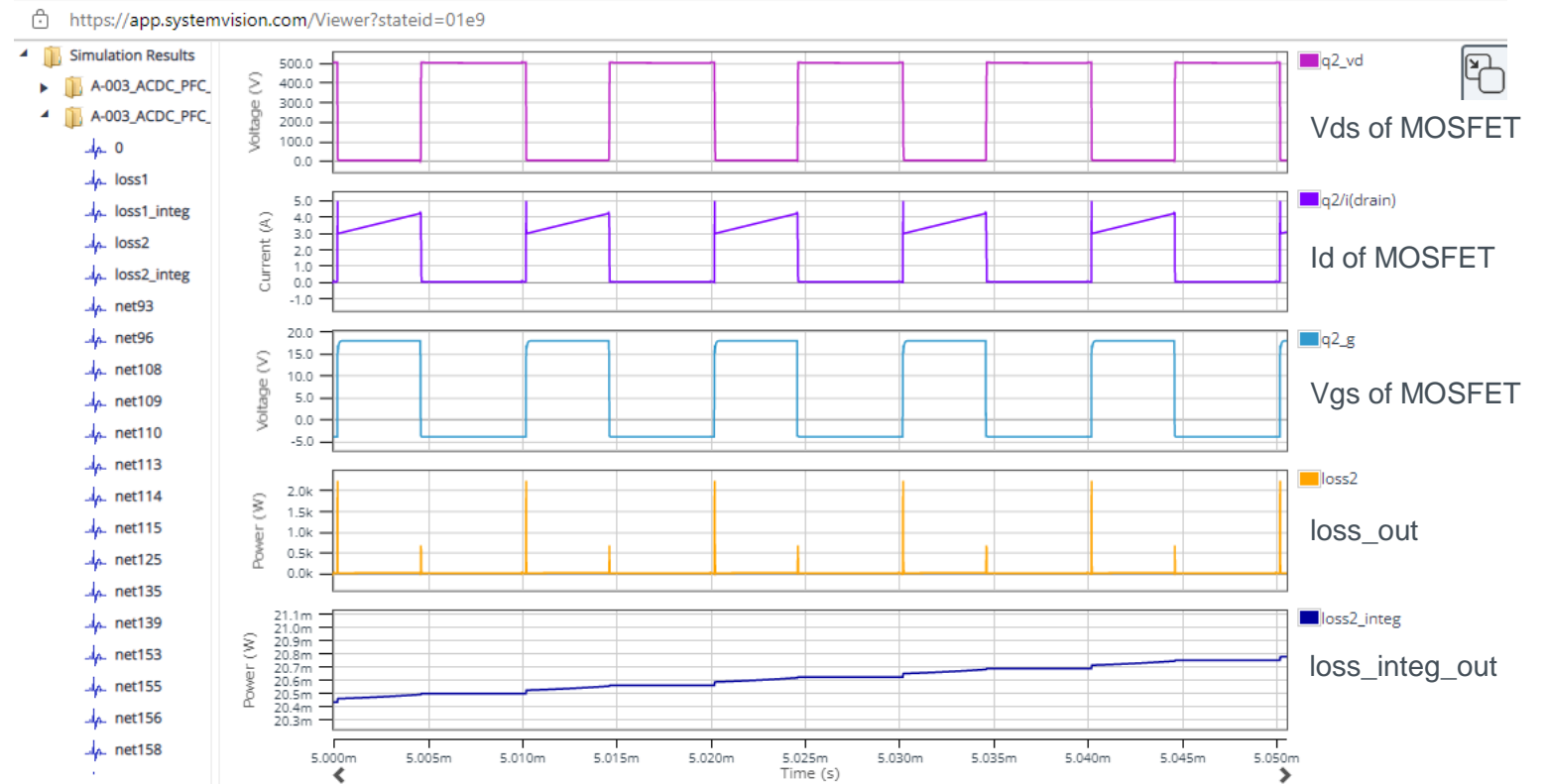

Notes

- 1) The information contained herein is subject to change without notice.
- 2) Before you use our Products, please contact our sales representative and verify the latest specifications :
- 3) Although ROHM is continuously working to improve product reliability and quality, semiconductors can break down and malfunction due to various factors.
Therefore, in order to prevent personal injury or fire arising from failure, please take safety measures such as complying with the derating characteristics, implementing redundant and fire prevention designs, and utilizing backups and fail-safe procedures. ROHM shall have no responsibility for any damages arising out of the use of our Products beyond the rating specified by ROHM.
- 4) Examples of application circuits, circuit constants and any other information contained herein are provided only to illustrate the standard usage and operations of the Products. The peripheral conditions must be taken into account when designing circuits for mass production.
- 5) The technical information specified herein is intended only to show the typical functions of and examples of application circuits for the Products. ROHM does not grant you, explicitly or implicitly, any license to use or exercise intellectual property or other rights held by ROHM or any other parties. ROHM shall have no responsibility whatsoever for any dispute arising out of the use of such technical information.
- 6) The Products specified in this document are not designed to be radiation tolerant.
- 7) For use of our Products in applications requiring a high degree of reliability (as exemplified below), please contact and consult with a ROHM representative : transportation equipment (i.e. cars, ships, trains), primary communication equipment, traffic lights, fire/crime prevention, safety equipment, medical systems, servers, solar cells, and power transmission systems.
- 8) Do not use our Products in applications requiring extremely high reliability, such as aerospace equipment, nuclear power control systems, and submarine repeaters.
- 9) ROHM shall have no responsibility for any damages or injury arising from non-compliance with the recommended usage conditions and specifications contained herein.
- 10) ROHM has used reasonable care to ensure the accuracy of the information contained in this document. However, ROHM does not warrants that such information is error-free, and ROHM shall have no responsibility for any damages arising from any inaccuracy or misprint of such information.
- 11) Please use the Products in accordance with any applicable environmental laws and regulations, such as the RoHS Directive. For more details, including RoHS compatibility, please contact a ROHM sales office. ROHM shall have no responsibility for any damages or losses resulting non-compliance with any applicable laws or regulations.
- 12) When providing our Products and technologies contained in this document to other countries, you must abide by the procedures and provisions stipulated in all applicable export laws and regulations, including without limitation the US Export Administration Regulations and the Foreign Exchange and Foreign Trade Act.
- 13) This document, in part or in whole, may not be reprinted or reproduced without prior consent of ROHM.



Thank you for your accessing to ROHM product informations.
More detail product informations and catalogs are available, please contact us.

ROHM Customer Support System

<http://www.rohm.com/contact/>